



METALCRAFT
THERMOSPAN/
THERMOPANEL EPS
PRODUCT DESIGN
GUIDE

VERSION March 2023



METALCRAFT THERMOSPAN/
THERMOPANEL PRODUCT
DESIGN GUIDE

metalcraftgroup.co.nz

CONTENTS

GENERAL	4
METALCRAFT CODEMARK EXPLAINED	5
APPLICATION OPTIONS	6
RESTRICTED BUILDING WORK	7
DESIGN REQUIREMENTS	7
THERMOPANEL PROPERTIES	8
THERMOPANEL LOADSPAN TABLE	9
THERMOPANEL THERMAL PROPERTIES	10
THERMOSPAN PROPERTIES	11
THERMOSPAN LOADSPAN TABLES	12
THERMOSPAN THERMAL PROPERTIES	13
STRUCTURAL PANEL WALL BRACING	14-21
WARRANTY GENERAL TERMS AND CONDITIONS	22
REFERENCE	23
BRANCH	24

GENERAL

This document is intended for designers and installers to ensure that Metalcraft Insulated Panels (ThermoSpan and ThermoPanel) are specified and installed correctly.

SUPPORTING INFORMATION

This document must be read in conjunction with the:

- CodeMark certificate: GM-CM30078 (RevC).
- CodeMark Declaration.
- Metalcraft PASS™ (Product Assurance Supplier Statement) for ThermoSpan and ThermoPanel Insulated Panels (V2.2 / June 2019).
- Metalcraft Specification for ThermoSpan and ThermoPanel Insulated Panels.
- Metalcraft Care and Maintenance (V1/May 2017).
- Metalcraft Warranty General Terms and Conditions (V1/May 2017).
- ThermoSpan - Commercial Roofing Guide (CREPS / 14/12/2018).
- ThermoSpan - Residential Roofing Guide (RREPS / 2016).
- ThermoPanel EPS - Controlled Environment Guide (TPEPS / 14/12/2018).
- ThermoPanel EPS - Wall Details (TPWD / 14/12/2018).
- Metalcraft ThermoSpan and ThermoPanel Data and Span Tables
- Engineering Reviews and Detailing
- Insulated Panel Industry Guides

COMPLIANCE WITH THE NEW ZEALAND BUILDING CODE (NZBC)

Where the Metalcraft Insulated Panel System is designed, installed and maintained in accordance with the conditions of CodeMark Certificate (No. GM-CM30078) the panel system will comply or contribute to compliance with the NZ Building Code.

USE OF METALCRAFT INSULATED PANELS

Metal faced insulated core panels are manufactured for use as finished roof and wall cladding systems. The physical properties of insulated panels with weathertight tongue and groove edge profile allow for quick and efficient construction. The panels are lightweight, strong, durable and the panel core provides both thermal insulation and fire resistance. The Metalcraft Insulated Panel System is a fully finished double sided internal/external wall and roofing system.

- The Metalcraft Insulated Panel System may be used as a structural panel system or non-load bearing system where it is fixed to a primary structural frame.
- The Metalcraft Insulated Panel System must be installed using ancillary products supplied with the system.
- The panels are manufactured from an expanded EPS core with factory laminated 0.59 mm COLORSTEEL® flat or profile facings. They are manufactured in the following thicknesses (mm): 50, 75, 100, 150, 200, 250, 300 for panel only.
- Panels can be made to ordered lengths.
- The Metalcraft Insulated Panels are branded as:
 - ThermoPanel
 - ThermoSpan
- System ancillary products supplied as part of the Metalcraft Insulation Panel System are:
 - 40 x 40 x 1.6 mm aluminium angles 12 mm hold-down bolts
 - 10 mm mushroom bolts
 - Flashings
 - Silicon sealant
 - 4.8 x 14.3 mm (ASMG63.66) aluminium rivets
 - 70 x 50 x 5 mm plate washers
- 14 gauge self-drilling screws with 25 mm steel washer Silicone sealant

METALCRAFT CODEMARK EXPLAINED

Metalcraft Insulated Panels is the certificate holder of CodeMark (GM-CM30078) for ThermoSpan and ThermoPanel Insulated EPS Panels. CodeMark is a third party certification, allowed for under the Building Act 2004. This means that under law, a Building Consent Authority must accept the specification of ThermoSpan and ThermoPanel EPS Insulated Panels (the panel and the installation details) as complying with the NZ Building Code, providing that all conditions of the certificate have been met.

Achieving CodeMark also focuses on the quality of ThermoSpan and ThermoPanel Insulated EPS Panels, and the quality and competence of the support provided by Metalcraft Insulated Panels. This means that designers and installers can use ThermoSpan and ThermoPanel Insulated

EPS Panels with confidence that, providing all instructions are followed, ThermoSpan and ThermoPanel Insulated EPS Panels will result in building work complying with the NZ Building Code.

CodeMark Certificate- GM-CM30078 issued by Global-Mark Pty.

Refer - MBIE, Product Performance

<https://www.building.govt.nz/building-codecompliance/product-assurance-and-multiproof/>



SCOPE OF USE

The Metalcraft Insulated Panel System is certified for use as a fully finished internal/ external wall system within the following scope:

- The Metalcraft Insulated Panel System must be specified and designed in accordance with all Metalcraft Insulated Panel System technical documentation.
Refer on-line www.metalcraftgroup.co.nz for current versions.
- In new buildings and where the Metalcraft Insulated Panel System is to be load bearing.
- In new buildings and where the Metalcraft Insulated Panel System is to be used as non-load bearing.
- Sub-floor and flooring structure (concrete, steel or timber) that comply with the NZ Building Code.
- A timber or steel framed structure that complies with the NZ Building Code.
- Existing buildings where the designer and installer are satisfied that the existing building is adequate for the intended building work.
- Joinery that complies with NZS4211:2008.
- A maximum building height of 10 m no closer than 1.0m to the relevant boundary.

LIMITATIONS

SITE CONDITIONS

1. The designer must consider the location regarding corrosion and environmental zones. The correct surface coating selection must be specified by the designer to ensure the long term performance of the Metalcraft Insulated Panel. The designer may refer to NZ Steel product selection table for (ISO Categories 1-5) or Metalcraft Insulated Panels for technical assistance.
2. The designer must consider the roofing profile in relation to roof slope to ensure that water can shed and allowance is made for snow loads in alpine conditions.
3. Metalcraft Insulated Panels can be used in wind zones up to and including extra high as defined in NZS 3604: 2011, section 5.
4. Metalcraft Insulated Panels have been tested to a wind pressure of 2.5kPa ULS where the design parameters exceed 2.5kPa specific design calculations in support of the proposed design will be required.
5. The designer must consider building location, proximity to relevant boundary and spread of fire AS/C1-6. ThermoSpan and ThermoPanel Insulated panels may not be suitable in these situations.
6. Where the Metalcraft Insulated Panel System is to be used in a microclimate (as defined in clause 4.2.2, NZS3604:2011) Metalcraft Insulated Panels must be consulted for technical advice.

BUILDING WORK CONDITIONS

1. Installation shall be carried out or supervised by someone who is experienced in installing insulated panels.

APPLICATION OPTIONS

The panels are suitable for a broad range of application options. Not all of these options are specifically covered within this installation guide. The following are brief descriptions of these options and reference to the primary source of installation instructions for each option.

IMPORTANT

Always refer to the project's installation drawings to confirm the specified panel applications and any specific installation requirements which may vary from the information in this installation guide.

- **Exterior Walls** - the installation of panels for the typical construction of exterior walls is shown in this installation guide.
- **Interior Walls (Partitions)** - the installation of the panels for the construction of interior walls or partitions is similar to the installation of exterior walls as shown in this guide, with exception of the base framing and flashing which may vary from the details in this guide. Caution: Because of the interference of interior overhead construction, the installation of interior walls may require different panel handling and lifting procedures than shown in this installation guide.
- **Vertical Panels** - the wall panels may be specified to be vertically oriented. Vertical oriented wall panels are set standing up on one end and joined side-by-side to construct the wall. The vertical panels are attached to horizontal framing members. The information in this installation guide shows how panels are installed in a vertical orientation.
- **Horizontal Panels** - the wall panels may be specified to be horizontally oriented. Horizontal oriented wall panels are set on their side and stacked on top of one another to construct the wall. The panel ends are aligned to form vertical end joints. The horizontal panels are attached to vertical framing members.
- **Architectural Flat Panels** - for architectural wall applications, the panels may be specified with a flat (no profile) exterior face. The installation of Architectural Flat wall panels is the same as the installation of exterior walls as shown in the guide, with the exception that the wall framing tolerances and panel handling requirements are more critical to avoid visible distortion of the panel face.
- **Parapet Walls** - the installation of panels which are extended to provide a parapet is similar to the installation of exterior walls as shown in this installation guide, with the exception that different head framing and flashing may be required.
- **Facades** - the installation of panels to construct a facade is similar to the installation of exterior walls as shown in this installation guide, with the exception that different framing and flashing may be required. Refer to the project's installation drawings for the specific requirements.
- **Cold Storage** - the installation of panels for cold storage applications is similar to the installation of panels for non-cold storage applications, with the exception that different perimeter flashing assemblies may be required for more critical vapour control and insulation continuity. The information in this guide shows the installation of typical flashing assemblies for both cold storage and non-cold storage applications.

NOTE: The details that relate to cold room construction are specific to this form of construction.

DESIGN REQUIREMENTS

RESTRICTED BUILDING WORK

In some applications Restricted Building Work (RBW) provisions will apply. It is the responsibility of the designer and installer to ensure that they have met their obligations under these provisions.

DESIGNER/INSTALLER SKILL

Where ThermoSpan and ThermoPanel Insulated EPS Panels are specified and/or installed the designer/installer should have the appropriate skills, knowledge of the product and access to all Metalcraft Insulated Panels technical information (refer www.metalcraftpanels.co.nz).

Where this Certificate is to be submitted with a building consent application, a signed declaration that the building work falls within the scope of this certificate and that all conditions of the certificate have been met must be submitted. The person signing this declaration must either have the appropriate Licensed Building Practitioner design license class for the building that is the subject of the building consent or be a Registered Architect or a Chartered Professional Engineer. They must also have ready access to all applicable technical documentation.

FINISHING & ADVICE

Metalcraft Insulated panels are dispatched from the factory with a plastic protective film. Once removed no additional surface finishing is required.

The surface coating applied to Metalcraft Insulated Panel by NZ Steel is a high quality durable surface coating that provided the coating is not scratched or damaged it will require no additional work.

It is recommended that all/any flashings required for weatherproofing or finishing should be specified at the time of design and be of the same grade and surface coatings as the insulated panel skin.

THERMOPANEL PROPERTIES

PANEL DIMENSIONS

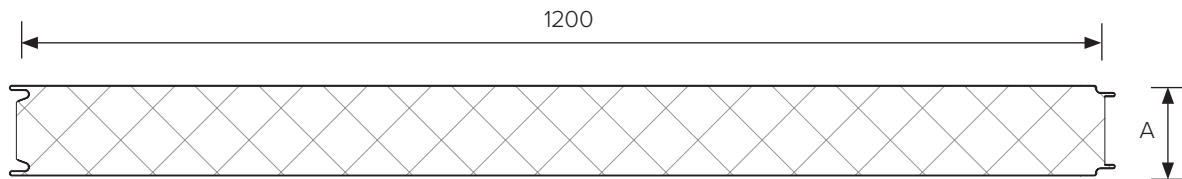

Dimensions, cover and sheet widths are all nominal and may vary with manufacturing and installation tolerances. Line drawings are indicative only and should not be scaled, if other dimensions are required please ask for them from Metalcraft Insulated Panels.

Panel Thickness Options = A
50, 75, 100, 125, 150, 175, 200 & 250mm

INNER PROFILE OPTIONS

ThermoPanel consists of 0.59mm steel bonded to an EPS core with a ceiling panel sheet bonded to the underside. ThermoPanel has a flame retardant additive to the EPS core and is available in a range of colour and ceiling profile finishes.

FLAT FINISH - AVAILABLE BOTH SIDES



SILKLINE FINISH - AVAILABLE 1 SIDE ONLY



MESA FINISH - AVAILABLE 1 SIDE ONLY

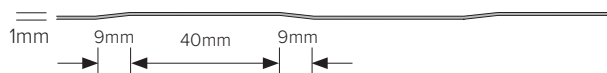

RIBBED FINISH - AVAILABLE BOTH SIDES

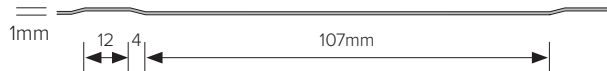

PRODUCT PROPERTIES

Core	EPS with flame retardant additive Class "S" Standard
External facing	0.59mm CP Grade Prepainted Galvanised Steel or Colorsteel® Endura® or Colorsteel® Maxx® The correct steel is dependent on the environmental category and corrosion zone. Please refer to Metalcraft.
Internal Facing	0.59mm CP Grade Prepainted Galvanised Steel
Effective cover ±1 mm	1200mm
Min. length ±1 500mm	1000mm
Length	Lengths are restricted by transportation to site. If longer than 15m check with Metalcraft. Max length up to 24m
Thickness	50mm, 75mm, 100mm, 125mm 150mm, 175mm, 200mm, 250mm
Flame retardant additive	Yes - ThermoPanel's EPS core has been treated with a flame retardant additive

THERMOPANEL LOADSPAN TABLE

FOR S.L.S VALUE WIND PRESSURES (kPa)

Thickness (mm)	Span (mm)										
	2500	3000	3500	4000	4500	5000	6000	6500	7000	7500	800
50	1.61	1.12	0.82	0.63	0.49						
75		1.68	1.23	0.94	0.74	0.60					
100		2.24	1.64	1.26	0.99	0.80	0.56				
125		2.80	2.05	1.57	1.24	1.00	0.70	0.59			
150			2.46	1.89	1.49	1.20	0.84	0.71	0.61		
175			2.88	2.20	1.74	1.41	0.98	0.83	0.72	0.62	0.55
200				2.52	1.99	1.61	1.12	0.95	0.82	0.71	0.63
250					2.48	2.01	1.40	1.19	1.02	0.89	0.78

THERMOPANEL STRENGTH AND FIXING CAPACITIES

Metalcraft Panel Specification.

The panel strength data in this document applies to Metalcraft Panel with 0.59 mm steel skins structurally bonded to a core of "S" grade expanded polystyrene (EPS).

The steel has yield strength of 300 MPa.

Notes

1. Permissible pressure values incorporate a factor of safety of 1.8 on ultimate strength.
2. This table applies to live loads only. For dead loads (eg long term loads) the strength capacity is reduced – refer to Metalcraft in such cases.
3. Calculate Ultimate Limit State Value: (kPa) = Permissible (kPa Value from table x 1.8 (safety factor) x 0.9 (material factor).

Table above is S.L.S

Definition of SLS – Is defines at the state of design beyond a structural system loses operationally its serviceability for the actual service load the structure is subjected to

METALCRAFT PANEL FIXINGS

- For Metalcraft Mushroom fixing with 10 mm threaded steel rod installed to Metalcraft details, Load Capacity perpendicular to face of the panel = 3 kN Permissible. Load Capacity parallel to and at the face of the panel = 1.0 kN Permissible.
- For 4mm (5/16") aluminium rivets attaching thin metal sections to Metalcraft panel skins, shear capacity of the connection = 0.45 kN Permissible per-rivet. For the shear capacity of a multi riveted connection, add the shear capacity of each rivet, provided the rivets considered are spaced at or more than 100 mm.
- For a 14 gauge Tek screw with 25 diameter steel washer fixed through the panel. Timber fix - type 17 14g screw 40mm embedment into timber substrate. Steel fix - 14g steelite screw minimum three full threads into steel structure. The permissible live load fixing capacity in the Metalcraft panel part of the connection is:
 - at 100 mm from the Metalcraft panel edge = 1.5 kN.
 - at 50 mm from the Metalcraft panel edge = 0.6 kN.

THERMOPANEL THERMAL PROPERTIES

THERMAL

The below total R-values are for insulation at an average temperature of 15°C. Contact us for other temperatures.

Panel Thickness (mm)	50	75	100	125	150	175	200	250
Mass Kg/m ²	11.30	11.60	12.00	12.30	12.70	13.0	13.30	14.00
U Value W/m ² K	0.76	0.51	0.38	0.30	0.25	0.22	0.19	0.15
R Value m ² K/W	1.32	1.97	2.63	3.29	3.95	4.60	5.26	6.60

THICKNESSES FOR CHILLERS & FREEZERS

Allow an additional 50mm thickness for walls and roofs exposed to direct sunlight.

- Consideration should be given to insulating floor detail.
- Values are guides only and are given for cool rooms operating under average ambient conditions.

CHILLERS / FREEZERS	
Temperature Degrees C	Panel Thickness
7.0 down to 3.0	75mm
3.0 down to -3.0	100mm
-3.0 down to -18.0	150mm
-18.0 down to -23.0	175mm
-23.0 down to -30.0	200mm

ISO 9705

ThermoPanel conforms to the requirements of the NZBC and has achieved a group 1S. Please note specific installation requirements are needed and available if required.

AS 2122.1-1993

Compliant to AS1366.3 Part 3
AWTA Test Report: 7- 561976-CO

COLOURS

Thermopanel available in 19 standard colours* from New Zealand Steel in trusted brands: COLORSTEEL® ENDURA® and COLORSTEEL® MAXX®. Colour brochures and steel swatches are available on request.

*Excluding Ebony. This is due to heat build up on dark colours and in the worst case potential delamination of steel from the core.

THERMOSPAN PROPERTIES

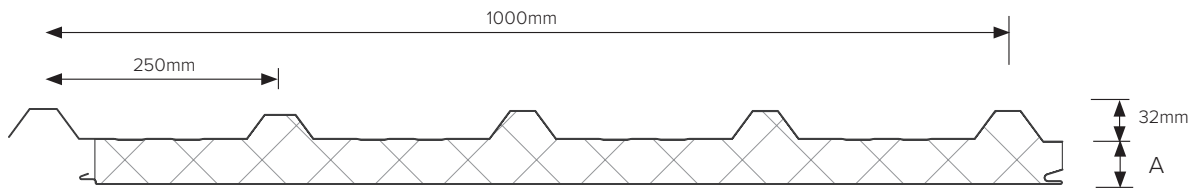

Dimensions, cover and sheet widths are all nominal and may vary with manufacturing and installation tolerances. Line drawings are indicative only and should not be scaled, if other dimensions are required please ask for them from Metalcraft Insulated Panels.

Panel Thickness = A
50, 75, 100, 125, 150, 175, 200 & 250mm

INNER PROFILE OPTIONS

ThermoSpan consists of 0.59mm profiled roofing sheet bonded to an EPS core with a ceiling panel sheet bonded to the underside. ThermoSpan has a flame retardant additive to the EPS core and is available in a range of colour and ceiling

FLAT FINISH - AVAILABLE INNER SKIN SIDE ONLY



SILKLINE FINISH - AVAILABLE INNER SKIN SIDE ONLY



MESA FINISH - AVAILABLE INNER SKIN SIDE ONLY

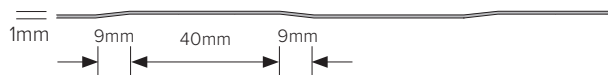

RIBBED FINISH - AVAILABLE INNER SKIN SIDE ONLY

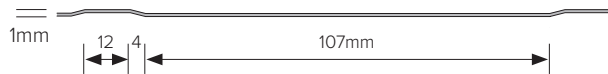

PRODUCT PROPERTIES

Core	EPS with flame retardant additive Class "S" Standard
External facing	0.59mm CP Grade Pre-painted Galvanised Steel or Colorsteel® Endura® or Colorsteel® Maxx® The correct steel is dependent on the environmental category and corrosion zone. Please refer to Metalcraft.
Internal Facing	0.59mm CP Grade Pre-painted Galvanised Steel
Effective cover ±1 mm	1000mm
Min. length ±1 500mm	1000mm
Length	Lengths are restricted by transportation to site. If longer than 15m check with Metalcraft. Max length up to 24m
Thickness	50mm, 75mm, 100mm, 125mm 150mm, 175mm, 200mm, 250mm
Flame retardant additive	Yes - ThermoSpan's EPS core has been treated with a flame retardant additive
Fire Rated	No
Fire Resistant	No
FM Approved	No
Min roof pitch	3°

THERMOSPAN LOADSPAN TABLES

THERMOSPAN LOADSPAN TABLE

FOR S.L.S VALUE WIND PRESSURES (kPa)

Thickness (mm)	Span (mm)															
	1500	1800	2100	2400	2700	3000	3300	3600	3900	4100	4500	4800	5100	5400	5700	6000
50	2.88	2.40	2.06	1.80	1.60	1.50	1.20	1.00	0.90	0.80	0.65	0.57	0.51	0.45		
75	3.00	2.50	2.14	1.87	1.67	1.61	1.36	1.25	1.15	1.10	0.93	0.82	0.72	0.64	0.58	0.52
100	3.75	3.20	2.78	2.45	2.20	2.00	1.84	1.70	1.59	1.52	1.33	1.22	1.02	0.94	0.90	0.63
125	3.83	3.54	2.99	2.68	2.32	2.10	2.18	2.00	1.93	1.88	1.56	1.37	1.21	1.08	0.97	0.87
150					4.30	3.95	3.61	3.00	2.58	2.25	1.87	1.64	1.45	1.30	1.16	1.05
175						4.29	3.85	3.55	3.00	2.60	2.20	1.85	1.62	1.42	1.28	1.20
200								4.00	3.55	3.00	2.35	2.00	1.70	1.51	1.37	1.25
250									4.10	3.85	3.61	3.00	2.55	2.23	2.10	1.98

- Pressures are maximum S.L.S values with a safety factor of 1.8 on the ultimate mean failure load.
- Where required, Ultimate Limit State Pressure values are obtained by multiplying table values by 1.8 (Safety factor) and 0.9 (Material factor). ie, Ultimate Limit State value (kPa) = Table value x 1.8 x 0.9 (kPa).
- The spans are for single spans, i.e. panel supported at the ends. The spans in multi-span cases are no greater than for the single span case.
- Deflection limit of Span / 150 for SLS has been applied.
- Non-trafficable maintenance access (concentrated load) of 110kg has been allowed for.

NOTES:

- The maximum permissible pull-out load on a rib fixing is 1.8 kN. Always check that adequate fixing capacity is provided.
- The spans are for single spans, i.e. panel supported at the ends. The spans in multi-span cases are no greater than for the single span case.
- The maximum overhang is 0.25 times the maximum span for the given conditions, provided this value does not exceed:
 - 600 mm for 50mm ThermoSpan
 - 1000 mm for 75mm ThermoSpan
 - 1200 mm for 100mm or thicker.

Longer cantilevers can be expected on thicker panels and require specific engineer design. Please consult Metalcraft Insulated Panels.

THERMOSPAN FIXINGS

Fixing with 14g tek screws (or equivalent) at each rib are required. Wall cladding is typically pan fixed.
 Timber fix - type 17 14g screw 40mm embedment into timber substrate. Steel fix - 14g steeltite screw minimum three full threads into steel structure.

THERMOSPAN THERMAL PROPERTIES

THERMAL

The below total R-values are for insulation at an average temperature of 15°C. Contact us for other temperatures.

Panel Thickness (mm)	50	75	100	125	150	175	200	250
Mass Kg/m ²	11.30	11.60	12.00	12.30	12.70	13.0	13.30	14.00
U Value W/m ² K	0.76	0.51	0.38	0.30	0.25	0.22	0.19	0.15
R Value m ² K/W	1.32	1.97	2.63	3.29	3.95	4.60	5.26	6.60

MINIMUM PITCH

Roof pitches will vary depending on the site conditions, loads, purpose, configuration, snow loading and span requirements.

Buildings designed with widely spaced purlins and portal frames may require a frame pitch increase of 1 or 2 degrees.

- Min. roof slope of 3 degree applies

ROOF NOISE

Metalcraft Insulated Panels advise the use of light colours and expansion detailing for long panels to mitigate potential noise issues that might arise within a ThermoSpan roof.

The homeowner, architect and designer should be aware that temperatures of dark colours are higher than those of lighter colours. Darker colours will thermally expand more.

Thermal expansion of metal roofs is covered in the NZMRM Code of Practice. The MBIE document on roof cladding advises that noise from thermal expansion is normal and should be expected. Refer to MBIE -Guide to tolerances, materials and workmanship in new residential construction 2015.

ISO 9705

ThermoSpan conforms to the requirements of the NZBC and has achieved a group 1S. Please note specific installation requirements are needed and available if required.

AS 2122.1-1993

Compliant to AS1366.3 Part 3
AWTA Test Report: 7- 561976-CO

STRUCTURAL PANEL WALL BRACING

Metalcraft ThermoSpan and ThermoPanel can be used as a structural bracing panel in most forms of construction. Bracing values can be assigned to the panels where used with a primary structural frame or stand-alone structural panel. Bracing units (BU's) can be derived from Metalcraft panel thicknesses of 100 mm and greater.

The use of BU's is intended for use with NZ3604 LTF types of construction and the BU rating assumes inherent redundancies associated with LTF buildings. BU capacities are not based on characteristic values but on mean ultimate values. Design engineers should be aware of these crucial differences and makes appropriate allowance for the resistance of critical structural elements. Consequently, where specifically designed bracing systems eg: steel portal frames or similar are used in conjunction with Metalcraft wall panel bracing systems, the use of strength reduction factors may be appropriate. It is noted that, in the design of SED bracing elements such as steel portal frames, the SLS limit for steel portal frame usually determines the frame size, so the above factors are not likely to influence design of SED bracing systems if an appropriate rational displacement based design methodology is used.

PRODUCT PROPERTIES		
Panel Type	ThermoPanel	ThermoPanel
Core Type	EPS	EPS
Minimum length (mm)	1200	610
Wind BU/m*	161	105
EQ BU/m*	175	116

NOTES

1. Based on a test wall height of 2.4 m (capacity adjustment for walls of other heights).
2. *Maximum BU/m= 120 for timber floors.
3. *Maximum BU/m= 150 for concrete floors.
4. 100BU's = 5kN ie: 1kN = 20Bu's.
5. Higher values indicated maybe used with SED subject to CPEng (NZ) engineer verifying the capacity of the hold-down connections.
6. Panels with large openings are not considered suitable as bracing panels ie: only panels with small penetrations such as power outlets and pipe penetrations less than 40 mm in diameter maybe used for bracing.

CAPACITY ADJUSTMENT FOR DIFFERENT WALL LENGTHS

The P21 test method allows the bracing capacity in BU's/m determined from the test to be applied to walls up to twice the tested wall length eg: for all test wall length of 1.12m, the bracing capacity maybe applied to wall up to 2.4m in length.

CAPACITY ADJUSTMENT FOR DIFFERENT HEIGHTS

The bracing capacity has been derived from tests of 2.4m high panels. NZS3604:2011 Sec 8.3.1.4 applies a pro-rata factor to the capacity of walls of heights greater than 2.4m but no adjustment is permitted for walls less than 2.1 m ie the rating must be the same as if the wall was 2.4m high.

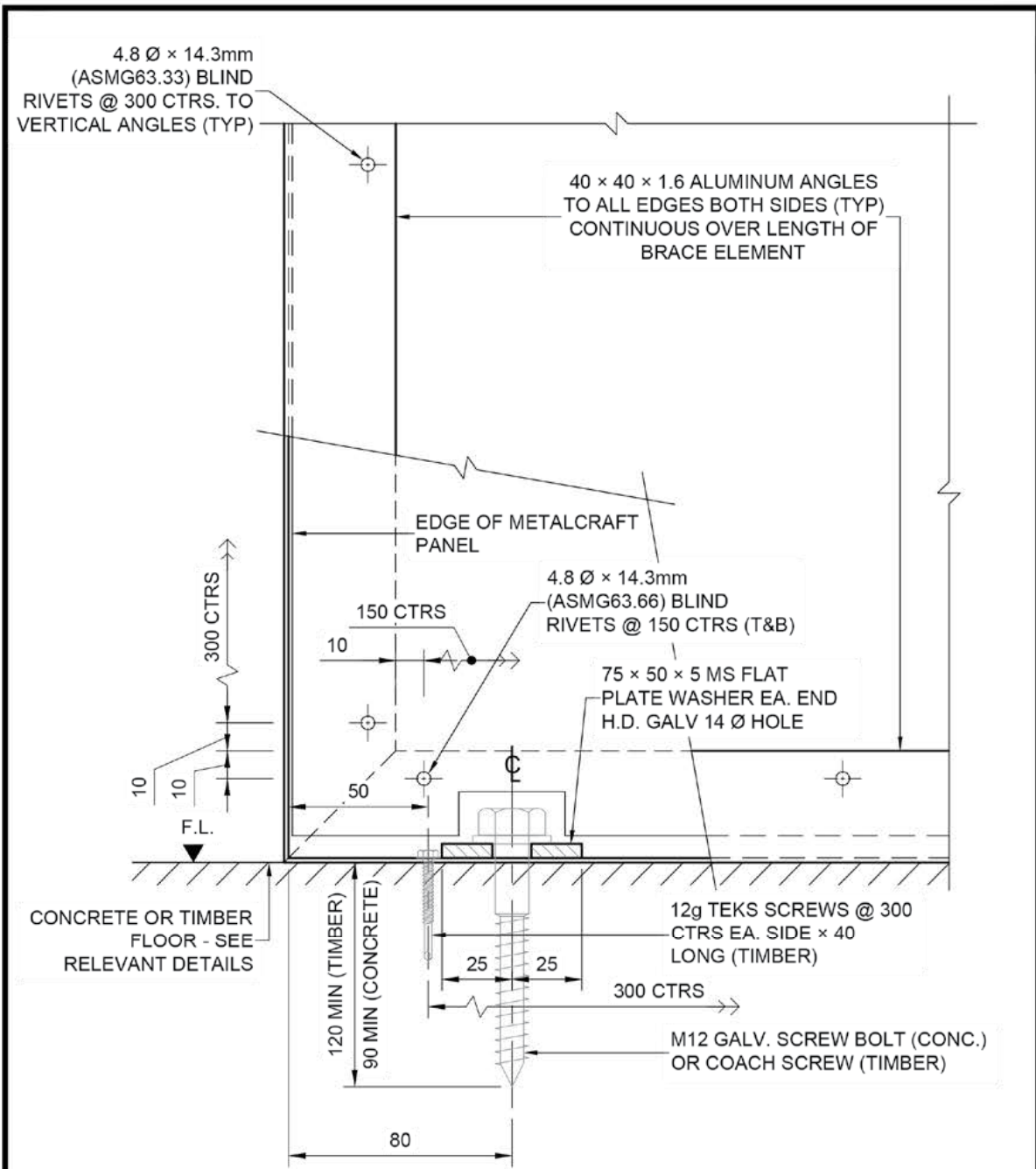

02 TYPICAL HOLD DOWN DETAILS
BR01

Checked By: RT

Scale: 1:2

Date: 09/2016

	METALCRAFT BRACING SYSTEMS	TYPICAL HOLD DOWN DETAILS	
		File No. 12191-01	Sht. No. BR02

CAD Filename: 12191-01-002-B01-B04.dwg

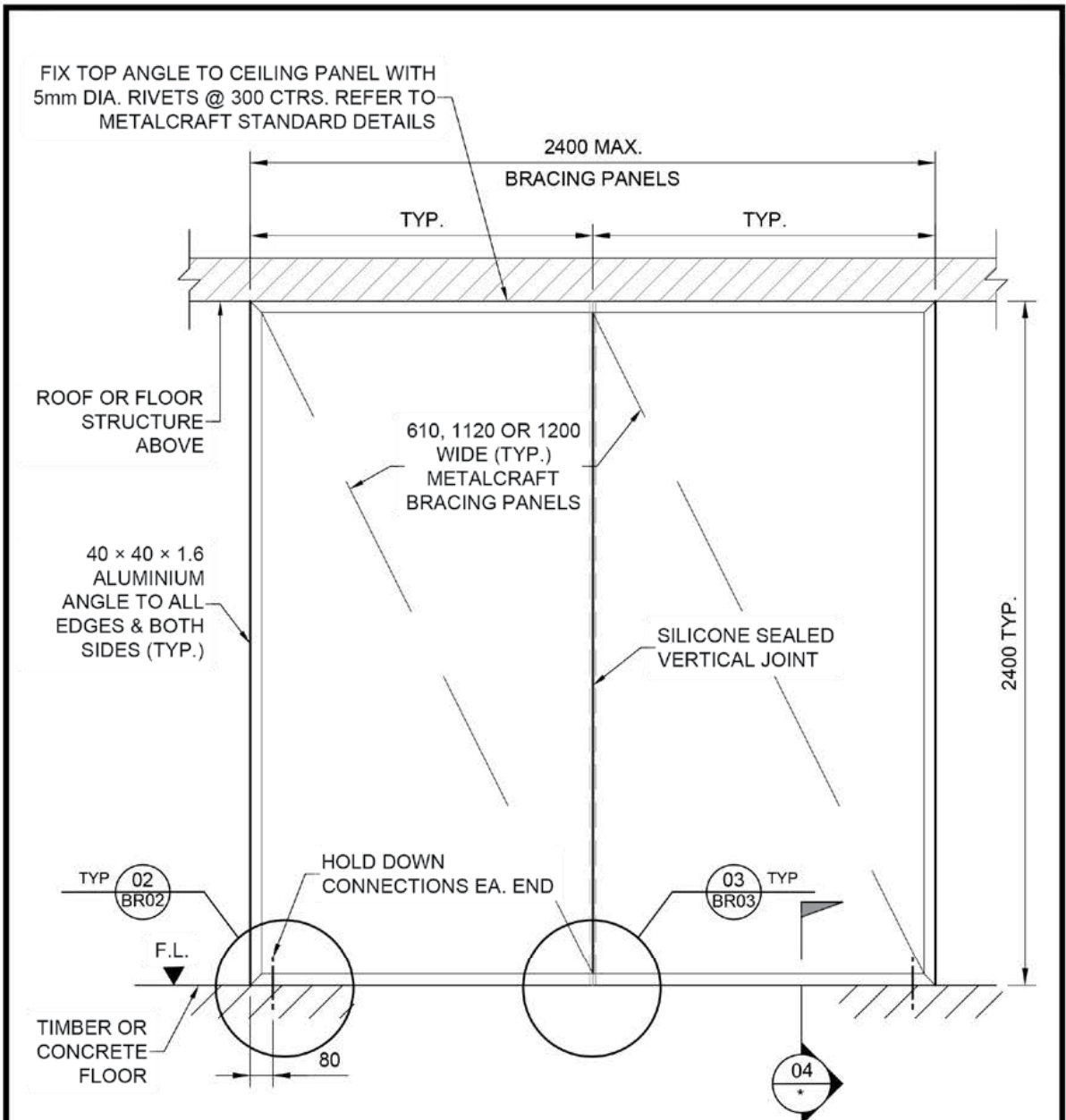

01 TYPICAL BRACING PANEL LAYOUT

- * REFER TO RELEVANT BR4 DETAILS:
- BR4-ET : EXTERNAL, TIMBER FLOOR
 - BR4-EC : EXTERNAL, CONCRETE FLOOR
 - BR4-IT : INTERNAL, TIMBER FLOOR
 - BR4-IC : INTERNAL, CONCRETE FLOOR

Checked By: RT

Scale: 1:20

Date: 09/2016

 <p>AIREY CONSULTANTS LTD.</p> <p>CONSTRUCTIVE & STRUCTURAL ENGINEERS Takapuna, Pukekohe, Howick, Queenstown</p>	<p>METALCRAFT BRACING SYSTEMS</p>	<p>TYPICAL BRACING PANEL LAYOUT - ELEVATION</p>	
		<p>File No. 12191-01</p>	<p>Sht. No. BR01</p>

CAD Filename: 12191-01-002-B01-B04.dwg

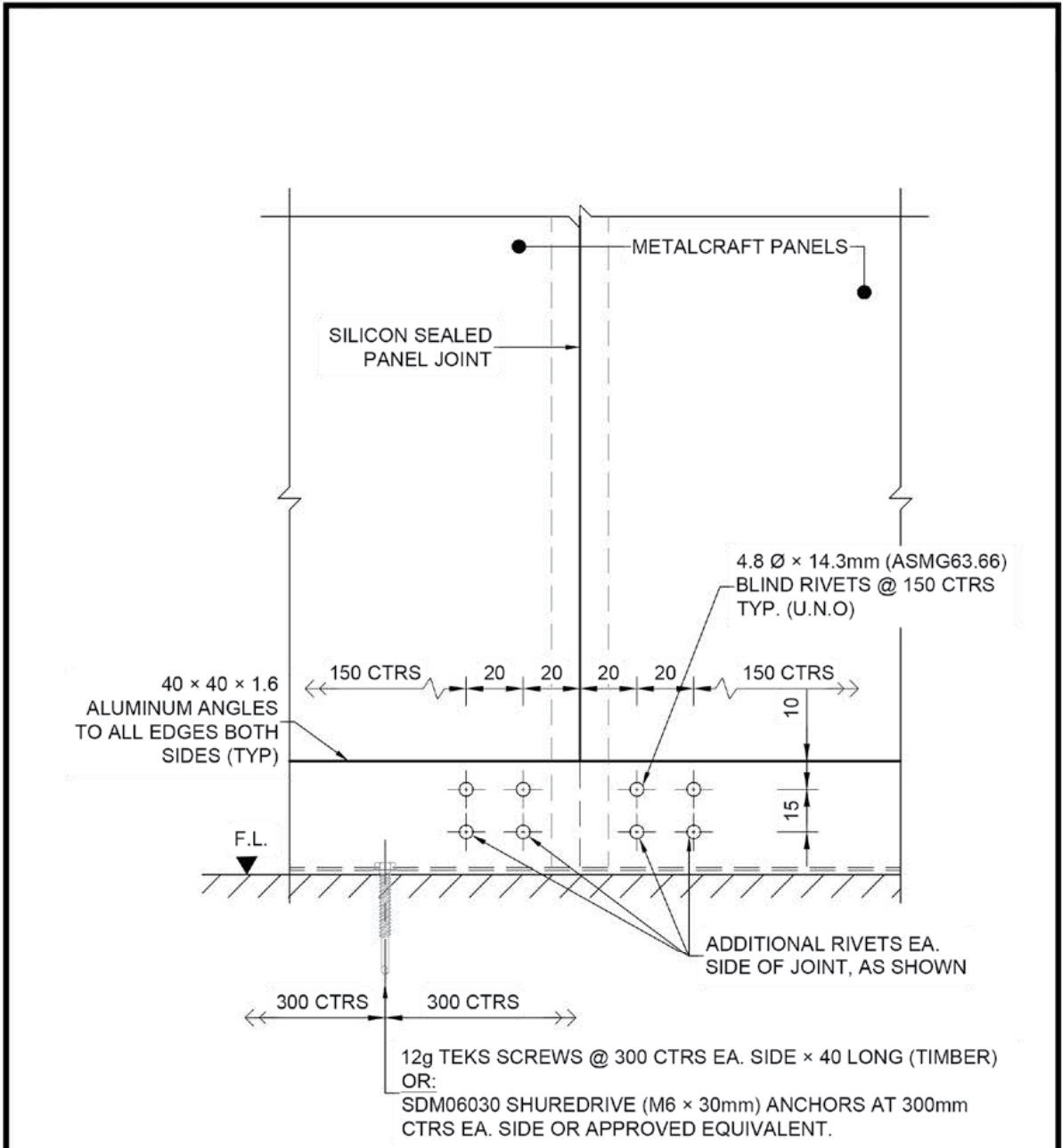

03 TYPICAL PANEL JOINT DETAIL
BR01

NOTE:

- DETAILS SIMILAR AT TOP & BOTTOM OF ALL BRACING PANELS, BOTH SIDES

Checked By: RT

Scale: 1:2

Date: 09/2016



METALCRAFT BRACING SYSTEMS

TYPICAL PANEL JOINT DETAIL	
File No. 12191-01	Sht. No. BR03

CAD Filename: 12191-01-002-B01-B04.dwg

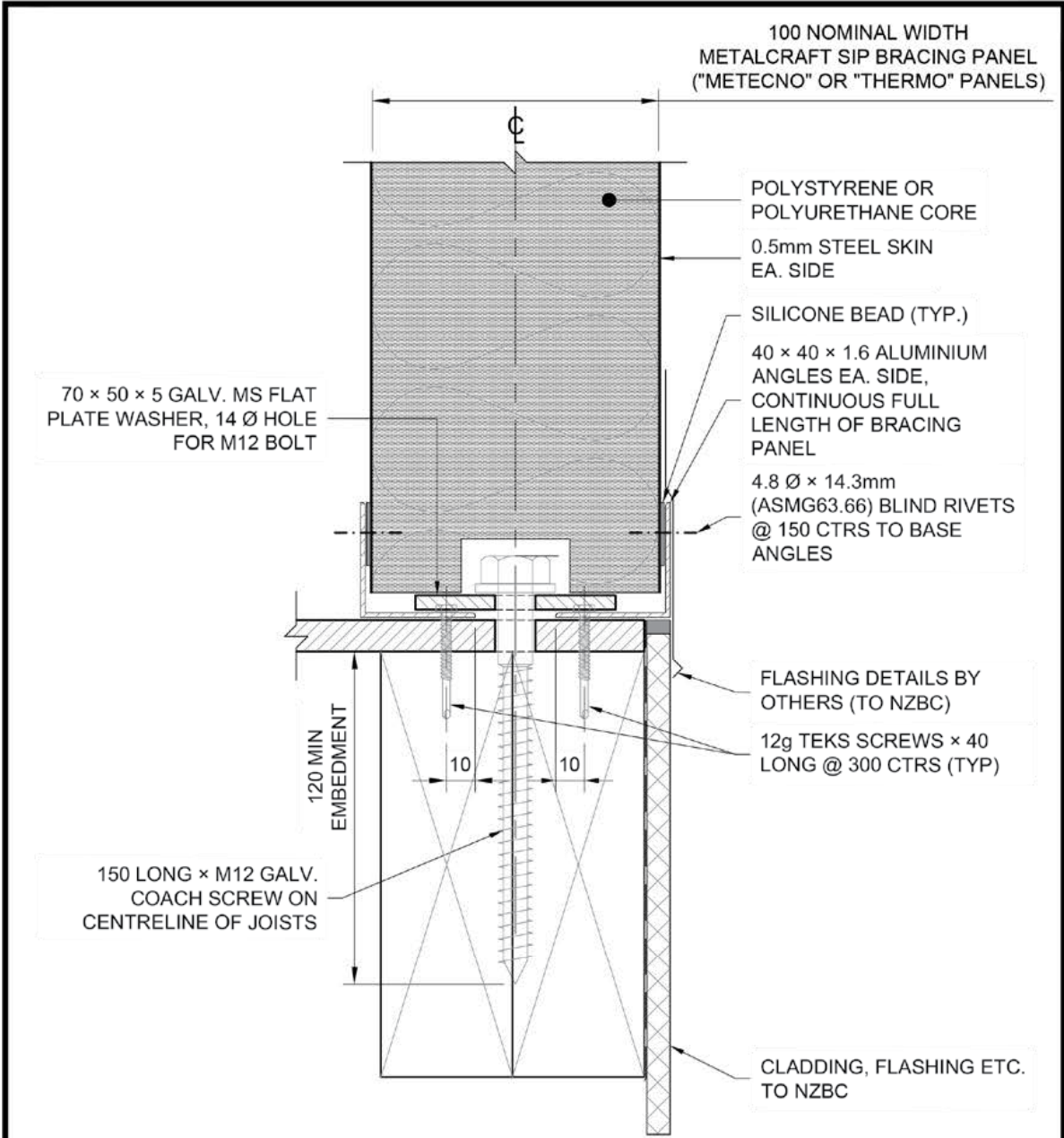

04 TYPICAL BRACING PANEL DETAILS
BR01 EXTERNAL TIMBER

NOTE:

- ALL TIMBER FLOOR DETAILS TO E2/AS1 & NZBC.

Checked By: RT

Scale: 1:2

Date: 09/2016

 <p>AIREY CONSULTANTS LTD.</p> <p>CONSULTING CIVIL & STRUCTURAL ENGINEERS Tairāpapa, Pukekohe, Howick, Queenstown</p>	<p>METALCRAFT BRACING SYSTEMS</p>	<p>TYPICAL BRACING PANEL DETAILS- EXTERNAL TIMBER</p>	
		<p>File No. 12191-01</p>	<p>Sht. No. BR4-ET</p>

CAD Filename: 12191-01-002-B01-B04.dwg

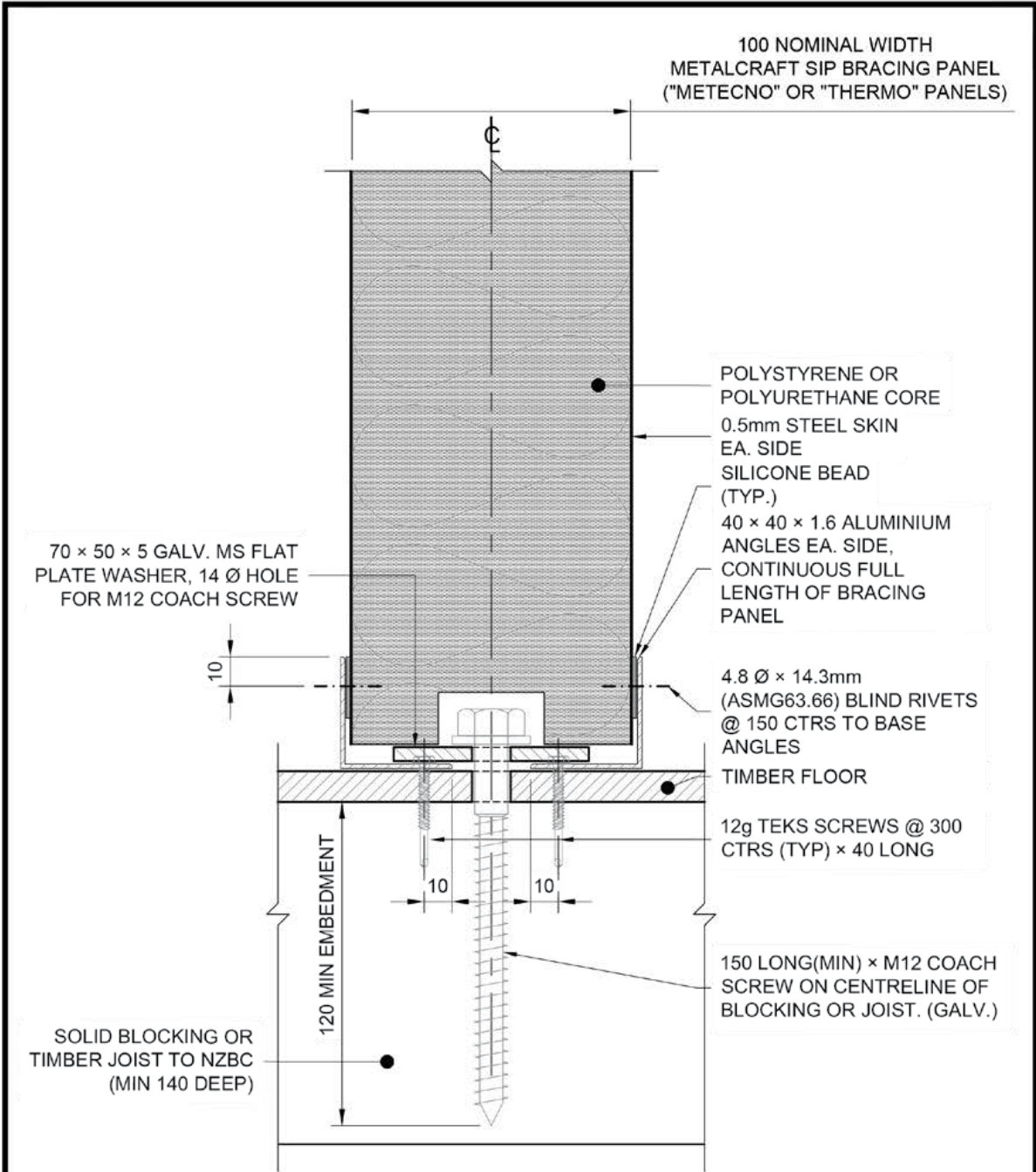

04 TYPICAL BRACING PANEL DETAILS
BR01 INTERNAL TIMBER FLOOR

Checked By: RT

Scale: 1:2

Date: 09/2016



METALCRAFT BRACING SYSTEMS

TYPICAL BRACING PANEL DETAILS - INTERNAL TIMBER	
File No. 12191-01	Sht. No. BR4-IT

CAD Filename: 12191-01-002-B01-B04.dwg

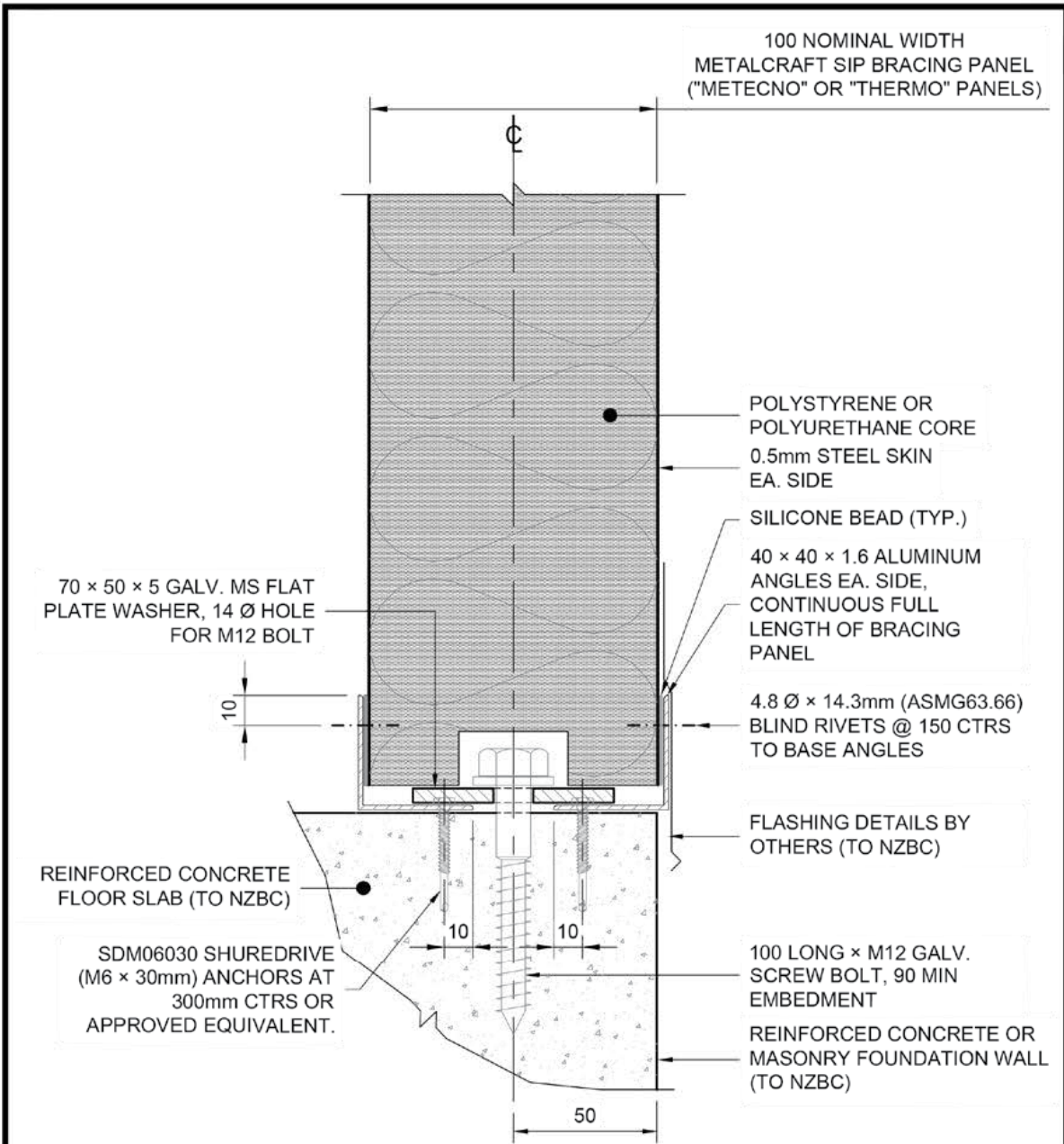

04 TYPICAL BRACING PANEL DETAILS
BR01 EXTERNAL CONCRETE FLOOR

Checked By: RT

Scale: 1:2

Date: 09/2016



METALCRAFT BRACING SYSTEMS

TYPICAL BRACING PANEL DETAILS - EXTERNAL CONC.

File No.
12191-01

Sht. No.
BR4-EC

CAD Filename: 12191-01-002-B01-B04.dwg

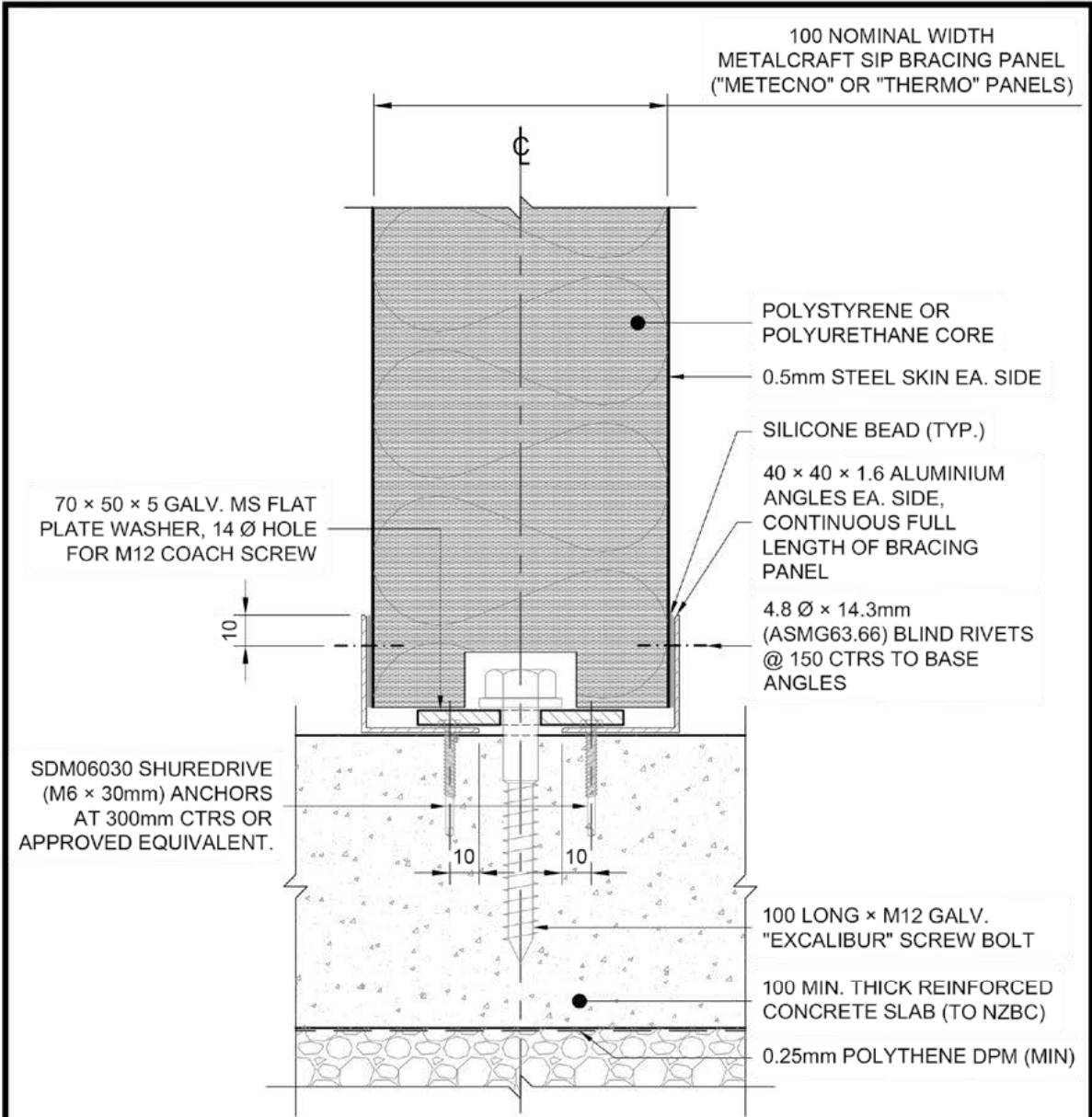

04 TYPICAL BRACING PANEL DETAILS
BR01 INTERNAL CONCRETE FLOOR
(NON-LOAD BEARING)

NOTE:

- LOAD BEARING WALL DETAILS SIMILAR BUT WITH SLAB THICKENING TO NZS 3604.

Checked By: RT

Scale: 1:2

Date: 09/2016



METALCRAFT BRACING SYSTEMS

TYPICAL BRACING PANEL DETAILS - INTERNAL CONC.

File No. 12191-01	Sht. No. BR4-IC
----------------------	--------------------

CAD Filename: 12191-01-002-B01-B04.dwg

WARRANTY GENERAL TERMS AND CONDITIONS

The warranty applies to Metalcraft Insulated Panel Systems where used in accordance with Metalcraft Insulated Panel Systems Information and requirements for a period: 15 years.

In addition to the Metalcraft Insulated Panel System warranty, NZ Steel warranty their 0.6mm COLORSTEEL® steel and coatings (subject to their specific warranty conditions).

Refer: Metalcraft Insulated Panels, Warranty General Terms and Conditions (v1/May 2017)

Refer: NZ Steel- <http://www.COLORSTEEL®.co.nz/products/COLORSTEEL®-maxx/>

Notes:

1. Roof pitches will vary depending on the site conditions, loads, purpose, configuration, snow loading and span requirements.
2. Building designed with widely spaced purlins and portal frames may require a frame pitch increase of 1.2%.
3. The Metalcraft Insulated Panel is an Alternative Solution under NZBC. The Metalcraft Insulated Panel is a deemed to comply building method, providing all conditions of the Certificate of Conformity are met.
4. See codemark details under metalcraft codemark explained.



REFERENCE

STANDARDS

- NZS3604: 2011- Light Timber Framed Buildings
- AS/NZS 1170: 2002- Structural Design Actions
- NZS4211:2008- Specification for performance of windows

LEGISLATION

- New Zealand Building Code: 1992
- NZ Building Act: 2004
- Product Assurance- Codemark (Certificate of Conformity No. GM-CM 30078)
- Health and Safety in Employment Act 1992

ADDITIONAL RESOURCES

- Insulated Panel Council Australasia Ltd(IPCA)- Code of Practice (004.3:2007)Ref- <http://www.insulatedpanelcouncil.org/code-of-practice-v2/>
- NZ Steel product and technical information



BRANCH

WIRI - METALCRAFT INSULATED PANEL SYSTEMS AUCKLAND

139 Roscommon Road, Wiri, Auckland
09 277 8844
sales@metpanels.co.nz
0800 Panels - 0800 726 357



HAMILTON

9 Earthmover Cres, Burbush, Hamilton
T: 07 849 3807
sales.hamilton@metpanels.co.nz



DISCLAIMER

As part of Metalcraft Roofing's policy of continued improvement, final specifications may vary from those contained in this publication. The company reserves the right at any time and without notice to change the design, materials or features and withdraw products from the market without incurring any liability whatsoever. This publication is issued as a general guide only and should not be treated as a substitute for technical advice. Contact with your nearest Metalcraft branch is recommended to confirm current specifications and availability. This document is un-controlled in printed format unless you subscribe for updates. All versions should be checked with those published on Metalcraft Roofing's website: www.metalcraftgroup.co.nz. To subscribe email: technical@metalcraftroofing.co.nz.



Metalcraft Roofing are members of the Roofing Association, New Zealand and the New Zealand Metal Roofing Manufacturers Incorporated.



For more information on Metalcraft Roofing visit:
www.metalcraftgroup.co.nz.
Metalcraft Roofing is part of United Industries Ltd. For more information on United Industries visit:
www.unitedindustries.co.nz.